

REDUCER SPEC	
MODEL	B153 TORQUE ARM
SERVICE FACTOR	
RATIO	
OUTPUT [rpm]	
OUTPUT TORQUE [Nm]	
WEIGHT [kg]	199

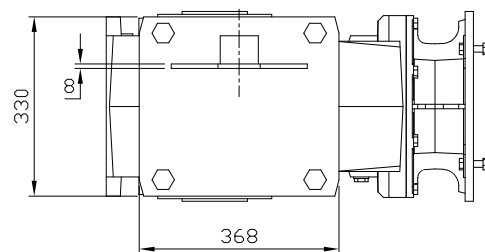
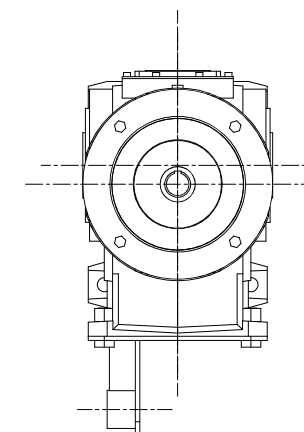
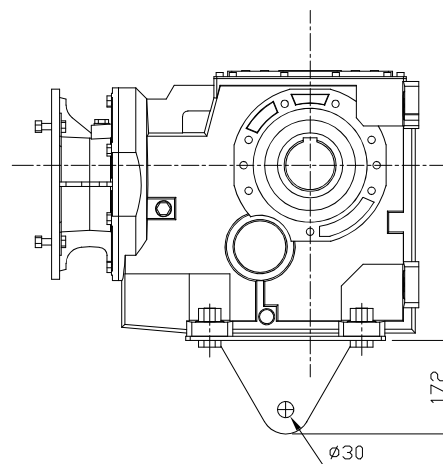
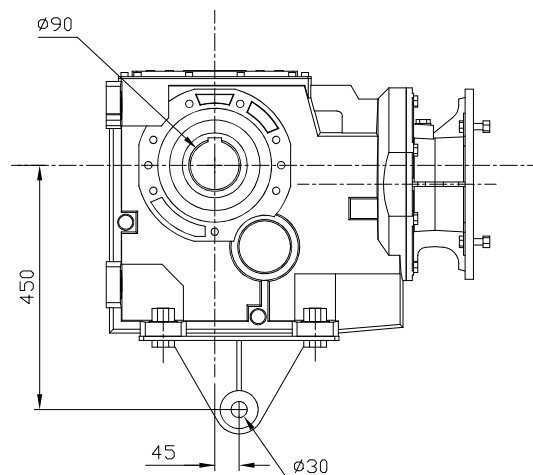
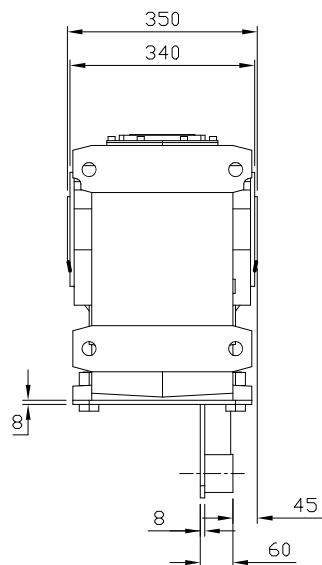
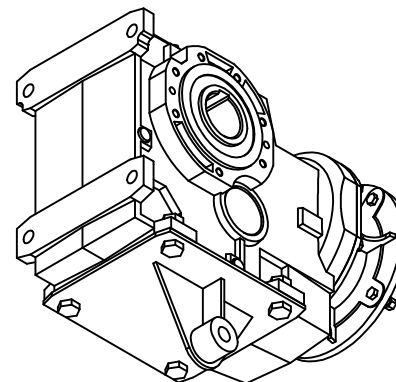
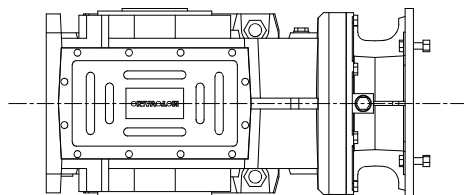

PROJECT		MOTOVARIO					
DRAWN	SEO Y.S	DATE		REV	A	SCALE	1:1
CHECKED	KIM J.S	DATE		UNIT	MM	PAGE	-
APPROVED	LEE J.Y	DATE		